

KD045XP0

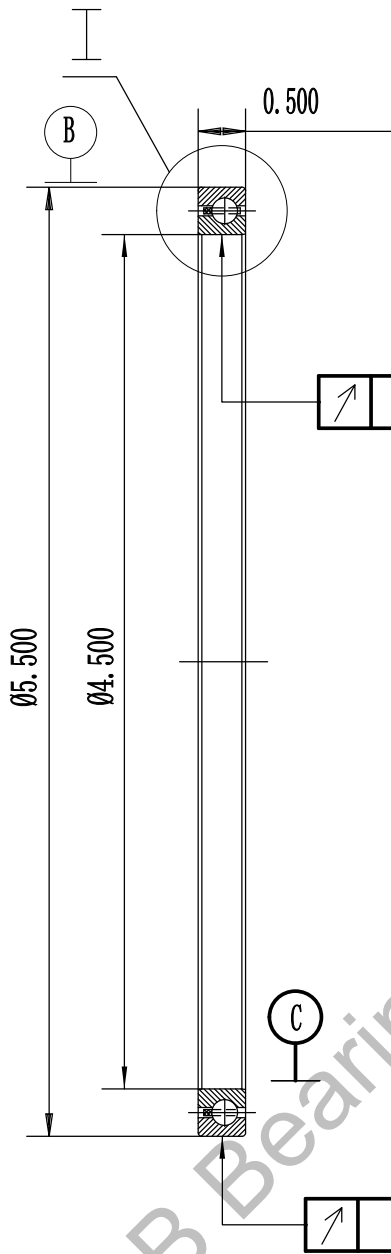

I enlarged view

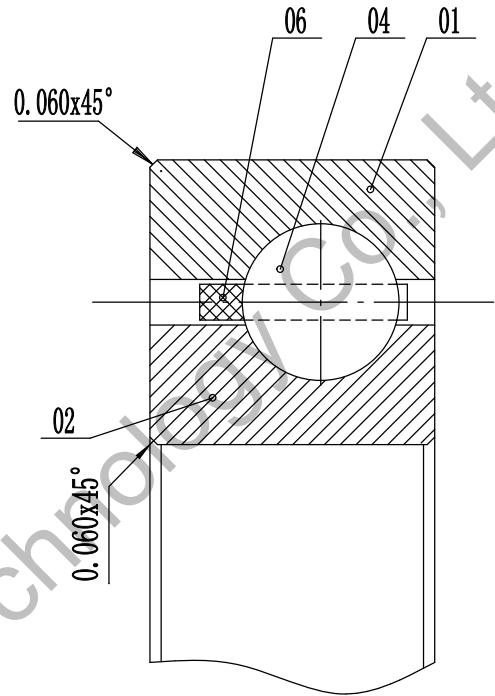

1. Radial clearance:



| 06 | cage | | nylon | | | |
|-----|-------------|-----|------------------|--------------|-------|--------|
| 04 | steel ball | | AISI 52100 Steel | | | |
| 02 | inner ring | 1 | AISI 52100 Steel | | | |
| 01 | outer ring | 1 | AISI 52100 Steel | | | |
| No. | designation | qty | material | unit | total | remark |
| | | | | weight (lbs) | | |

Luoyang JCB Bearing Technology Co., Ltd
 Contact information
 Company Address : No.285 Fenghua road, Luoyang, Henan, China.
 Postal code : 471000
 Phone : 0086-379-68611678 Fax : 0086-379-68611679
 E-mail: sales@jcb-bearing.com
 Reserved E-mail: sales@thinsectionbearings.com
 Website: www.jcb-bearing.com
 www.thinsectionbearings.com

THIN SECTION BEARING

KD045XP0

weight(lbs)

0.88

total page 1

page 1

Luoyang JCB Bearing Technology Co., Ltd